



MN1400

Size: C (LR14)

Alkaline-Manganese Dioxide Battery

Zn/MnO₂

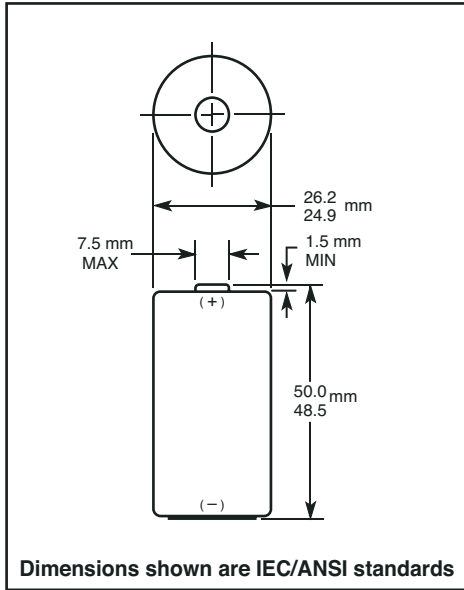

Nominal Voltage:	1.5 V
Operating Voltage	1.6 - 0.75V
Impedance:	150 m-ohm @ 1kHz
Typical Weight:	69 gm (2.4 oz.)
Typical Volume:	26.9 cm ³ (1.6 in. ³)
Terminals:	Flat
Storage Temperature Range:	-20 °C to 35 °C
Operating Temperature Range:	-20 °C to 54 °C (-4 °F to 130 °F)
ANSI:	14A
IEC:	LR14

TYPICAL DISCHARGE CHARACTERISTICS AT 21 °C (70 °F)

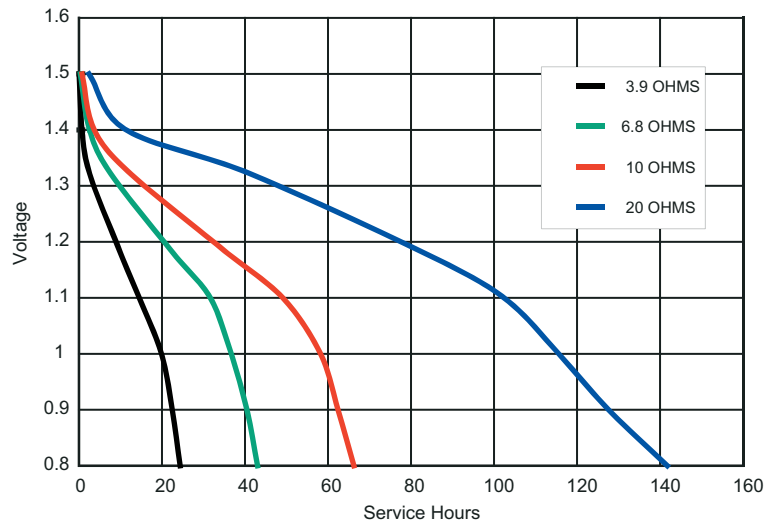

DURACELL[®]
BATTERIES

Berkshire Corporate Park
Bethel, CT 06801 U.S.A.
Telephone: Toll-free 1-800-544-5454
Internet: www.duracell.com

* Delivered capacity is dependent on the applied load, operating temperature and cut-off voltage. Please refer to the charts and discharge data shown for examples of the energy / service life that the battery will provide for various load conditions.



MN1400

Size: C (LR14)

Alkaline-Manganese Dioxide Battery

Zn/MnO₂

TYPICAL DISCHARGE CHARACTERISTICS AT 21°C (70°F)

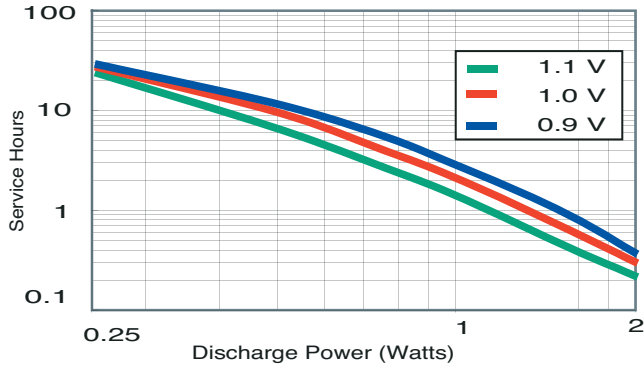

TYPICAL DISCHARGE CHARACTERISTICS AT 21°C (70°F)

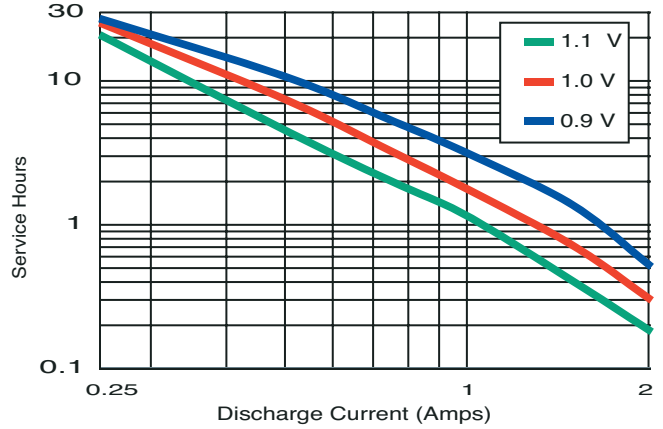

TYPICAL DISCHARGE CHARACTERISTICS AT 21°C (70°F)

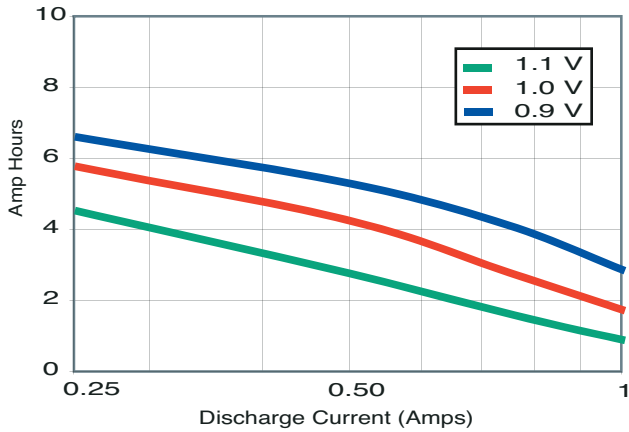

TYPICAL DISCHARGE CHARACTERISTICS AT 21°C (70°F)

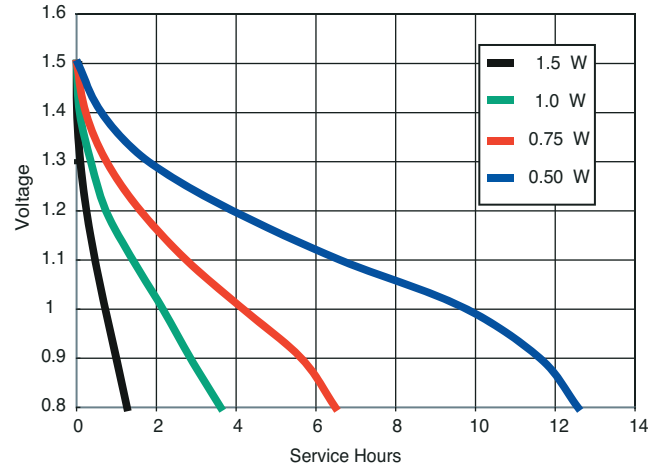

TYPICAL FLASHLIGHT TEST AT 21°C AND 0°C

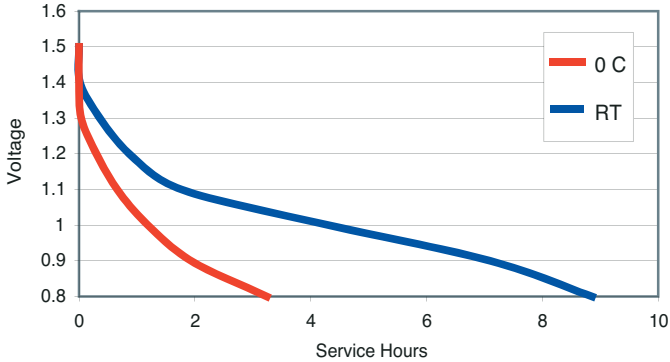

DURACELL[®]
BATTERIES

Berkshire Corporate Park
Bethel, CT 06801 U.S.A.
Telephone: Toll-free 1-800-544-5454
Internet: www.duracell.com

* Delivered capacity is dependent on the applied load, operating temperature and cut-off voltage. Please refer to the charts and discharge data shown for examples of the energy / service life that the battery will provide for various load conditions.